

Agilent Lightwave Solution Platform

Configuration Guide
July 2003

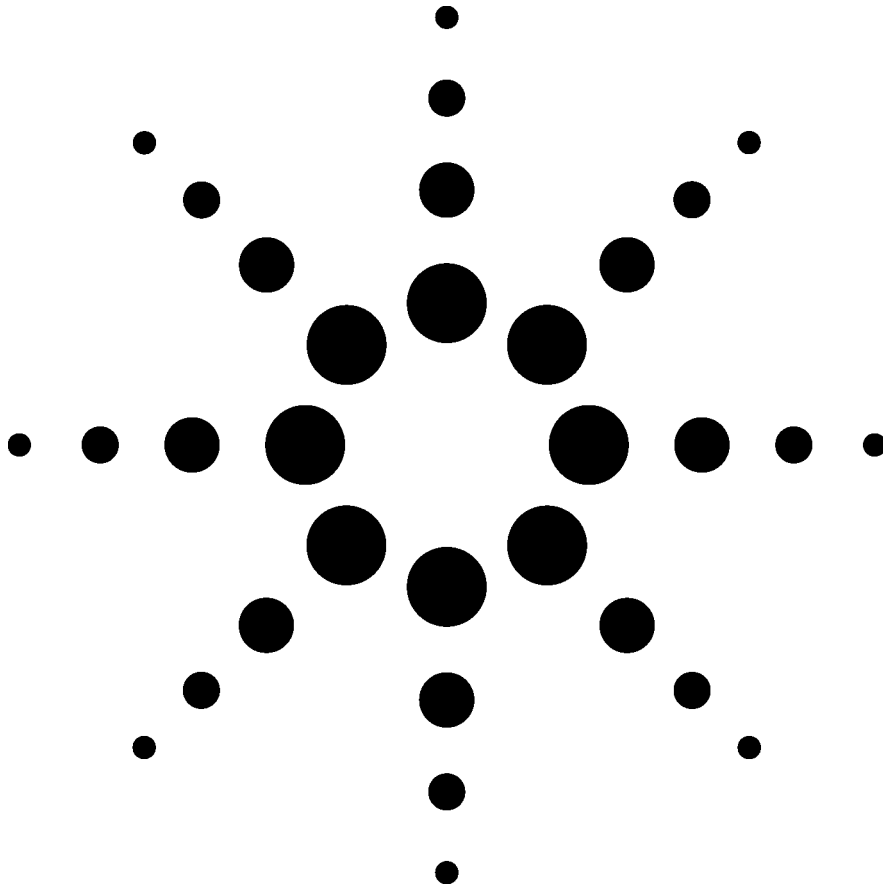

This guide provides configuration details for the Agilent 816xB family of mainframes and modules, including options and accessories.



Agilent Technologies

8163B Lightwave Multimeter



Main features:

- Ideal for laboratory and portable usage
- 2 compact module slots
- Built in applications:
Return Loss, Passive Component Test, Stability, Logging
- GPIB Interface for remote control
- Full backward compatibility for 815xx and 816xx series modules.

8164B Lightwave Measurement System



Main features:

- Ideal for laboratory or rack mount usage for state-of-the-art applications
- 1 extended module slot for backloadable tunable laser sources
- 4 compact module slots
- Built in applications:
Passive Component Test, Stability, Logging
- Integrated floppy disk for direct setup and data access
- GPIB Interface for remote control
- Full backward compatibility for 815xx and 816xx series modules.

8166B Lightwave Multichannel System



Main features:

- Ideal for laboratory or rack mount usage for applications that require high port counts
- 17 compact module slots
- GPIB Interface for remote control
- Backward compatibility for 8156x, 8157x, 8159x and 816xx series modules.

Module compatibility

		8163B Slots 1 - 2	8164B Slot 0	8164B Slots 1 - 4	8166B Slots 1 - 17
81600B TLS family #200, #160, #150, #140 low SSE #142, #132 high power	page 4 page 4		X X		
81980A compact TLS	page 5	X		X	X
81940A compact TLS	page 5	X		X	X
81989A compact TLS	page 5	X		X	X
81949A compact TLS	page 5	X		X	X
81662A dfb source module	page 6	X		X	X
81663A dfb source module	page 6	X		X	X
81650A fp source module	page 7	X		X	X
81651A fp source module	page 7	X		X	X
81654A fp source module	page 7	X		X	X
81630B power measurement module	page 8	X		X	X
81634B power measurement module	page 8	X		X	X
81635A power measurement module	page 8	X		X	X
81636B power measurement module	page 8	X		X	X
81618A interface module	page 9/10	X		X	X
81619A dual interface module	page 9/10	X		X	X
81623B optical head	page 9	X		X	X
81624B optical head	page 9	X		X	X
81626B high power optical head	page 9	X		X	X
81628B high power optical head with integrating sphere	page 10	X		X	X
81610A return loss module	page 11	X		X	X
81611A return loss module	page 11	X		X	X
81612A return loss module	page 11	X		X	X
81613A return loss module	page 11	X		X	X
81570A attenuator module	page 12	X		X	X
81576A attenuator module with p/c	page 12	X		X	X
81573A attenuator module (pigtail)	page 12	X		X	X
81571A attenuator module	page 12	X		X	X
81577A attenuator module with p/c	page 12	X		X	X

Legacy Module compatibility

The discontinued 8163A, 8164A and 8166A mainframes are functionally compatible with the B versions.

		8163B Slots 1 - 2	8164B Slot 0	8164B Slots 1 - 4	8166B Slots 1 - 17
814xxA/B backloadable TLS modules			X		
816xxA/B backloadable TLS modules			X		
816xxA/B compact TLS modules		X		X	X
Other 816xx series modules		X		X	X
8156xA attenuator modules		X		X	X
8159xA/S switch modules		X		X	X
All other 815xx series modules		X		X	

81600B Tunable Laser Source family

OPTIONAL

MANDATORY AND MUTUALLY EXCLUSIVE

For Laser Safety see page 13



Tunable Laser Sources Low SSE modules

- 81600B #200:
1440 nm – 1640 nm
- 81600B #160:
1495 nm - 1640 nm
- 81600B #150:
1450 nm - 1590 nm
- 81600B #140:
1370 nm - 1495 nm

Tunable Laser Sources

Outputs:
Low SSE
and High Power

Tunable Laser Sources

Outputs:
High Power
only

Tunable Laser Sources High Power modules

- 81600B #142:
1370 nm - 1495 nm, + 8.5 dBm
- 81600B #132:
1260 nm - 1375 nm, + 9 dBm

81600B-003
with built-in
attenuator
(81600B #142 only)

81600B-071
PMF Straight
contact connector

81600B-072
PMF Angled
contact connector

Connector Interfaces for straight connectors

- 2 ea required for 81600B #200,160,150,140.
- 1 ea required for 81600B #142, 132.

Connector Interfaces
for straight
connectors

Connector Interface for angled connectors

- 2 ea required for 81600B #200,160,150,140.
- 1 ea required for 81600B #142, 132.

Connector Interfaces
for angled
connectors

- 81000FI FC/PC
- 81000HI E-2000/PC
- 81000KI SC/PC
- 81000LI LC/PC
- 81000MI MU/PC
- 81000SI DIN 47256/PC
- 81000VI ST/PC

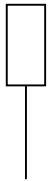

- 81000FI FC/APC keywidth 2.2mm
- 81000NI FC/APC keywidth 2.0mm
- 81000HI E-2000/APC
- 81000KI SC/APC
- 81000LI LC/APC
- 81000MI MU/APC
- 81000SI DIN 47256/APC



Note: 81600B - 072 is highly recommended over 81600B - 071 to reduce front-panel reflections, which will greatly reduce interference noise and spectral ripple in the test setup.

High Power Compact Tunable Laser Source modules

OPTIONAL

MANDATORY AND MUTUALLY EXCLUSIVE

For Laser Safety see page 13



High Power Compact Tunable Laser Source module

High Power Compact Tunable Laser module

- 81980A Compact Tunable Laser 1465 nm - 1575 nm
- 81940A Compact Tunable Laser 1520 nm - 1630 nm
- 81989A Compact Tunable Laser 1465 nm - 1575 nm
- 81949A Compact Tunable Laser 1520 nm - 1630 nm

819xxA-071
PMF
Straight contact connector

819xxA-072
PMF
Angled contact connector

Connector Interfaces for straight connectors

1 ea required

- 81000FI FC/PC
- 81000HI E-2000/PC
- 81000KI SC/PC
- 81000LI LC/PC
- 81000MI MU/PC
- 81000SI DIN 47256/PC
- 81000VI ST/PC

Connector Interfaces for straight connectors

Connector Interfaces for angled connectors

Connector Interfaces for angled connectors

1 ea required

- 81000FI FC/APC keywidth 2.2mm
- 81000NI FC/APC keywidth 2.0mm
- 81000HI E-2000/APC
- 81000KI SC/APC
- 81000LI LC/APC
- 81000MI MU/APC
- 81000SI DIN 47256/APC
- 81000VI ST/APC

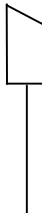

Note: 819xxA - 072 is highly recommended over 819xxA - 071 to reduce front-panel reflections, which will greatly reduce interference noise and spectral ripple in the test setup.

DFB Source modules

OPTIONAL

MANDATORY AND MUTUALLY EXCLUSIVE

For Laser Safety see page 13

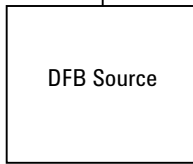

81662A DFB Source, + 10 dBm C- and L- band
81663A DFB Source, + 13 dBm C-and L-band

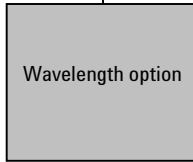

Wavelength determined by option number
For special wavelengths, contact Agilent.

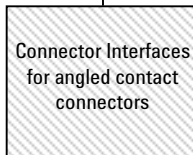

Connector Interfaces for angled connectors

1 ea required

- 81000FI FC/APC keywidth 2.2mm
- 81000NI FC/APC keywidth 2.0mm
- 81000HI E-2000/APC
- 81000KI SC/APC
- 81000LI LC/APC
- 81000MI MU/APC
- 81000SI DIN 47256/APC
- 81000VI ST/APC



Fabry-Perot Laser modules

OPTIONAL

For Laser Safety see page 13



Source Modules
SMF,
Straight contact
interface

**FP High Power
Source Modules 13 dBm**

- 81655A 1310nm
- 81656A 1550 nm
- 81657A 1310/1550 nm

**FP Standard
Source Modules 0 dBm**

- 81650A 1310 nm
- 81651A 1550 nm
- 81654A 1310/1550 nm

Connector
Interfaces for
straight
connectors

Connector Interfaces for straight connectors

1 ea required

- 81000FI FC/PC
- 81000HI E-2000/PC
- 81000KI SC/PC
- 81000LI LC/PC
- 81000MI MU/PC
- 81000SI DIN 47256/PC
- 81000VI ST/PC

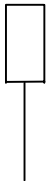

Optical Power Measurement modules

OPTIONAL

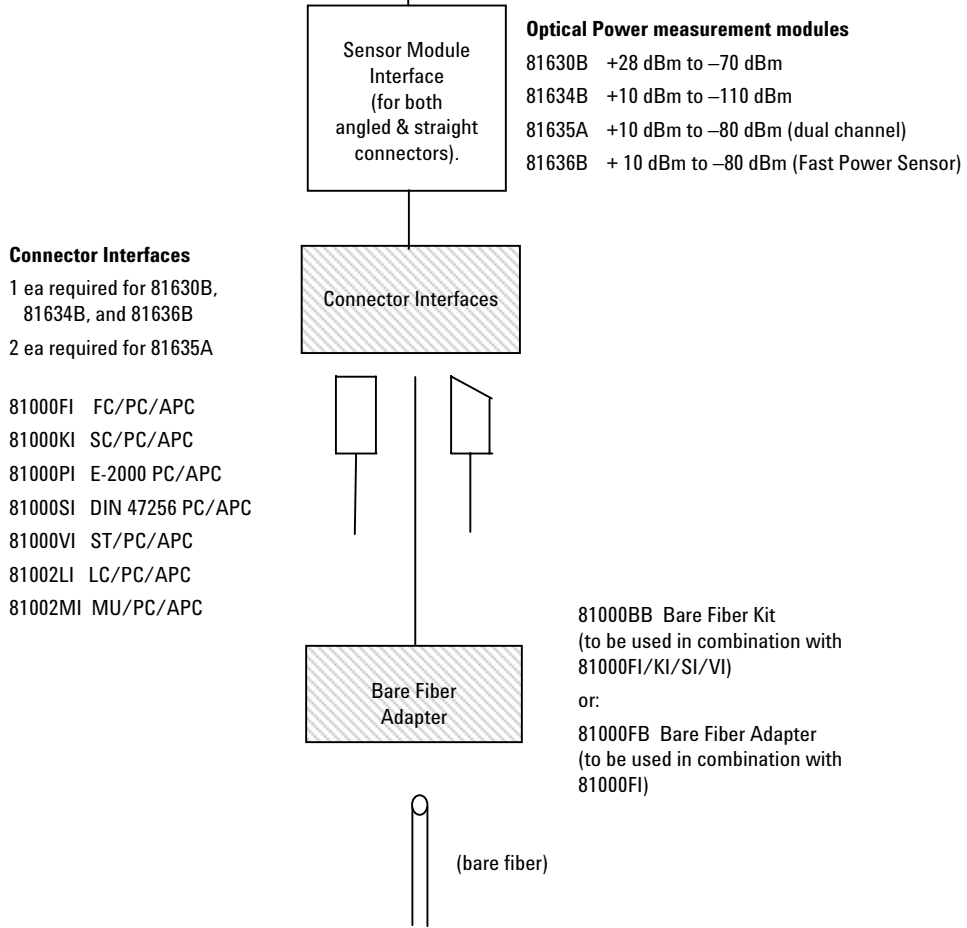

Note: All sensor inputs are non-contact and accept both straight and angled connectors.

Optical Heads (5mm sensor)

OPTIONAL



Interface Module

Interface Modules

- 81618A Single Head Interface Module
- 81619A Dual Head Interface Module

Accessories

- 81624CE 4m extension cable
- 81624DD additional D-shape quick change adapter
- 81624RM Half-rack Mount Kit for 2 Heads
- 81625RM Rack Mount Kit for 4 Heads

Optical Heads for:
Connectorized Fiber,
Bare Fiber and
Open beam $NA \leq 0.3$

Optical Heads

- 81623B Ge +10dBm to -80 dBm
- 81624B InGaAs +10dBm to -90 dBm
- 81626B InGaAs +27dBm to -70 dBm

D-Shaped Adapter 81624DD
(supplied with head)

[1] For use with 81626B and straight connectors. If input power > +10dBm the use of the filter holder will result in better accuracy (refer to specifications).

Filter Holder [1]

Filter / Holder

- 81000AF Filter Holder
- 81001FF 10 dB Filter and Holder

High Return Loss Adapter

(for use with straight connectors)
81000RA High Return Loss Adapter

High Return Loss Adapter

Connector Interfaces for straight connectors

- 81000FI FC/PC
- 81000PI E2000/PC
- 81000KI SC/PC
- 81000SI DIN 47256/PC
- 81000VI ST/PC

- 81002LI LC/PC
- 81002MI MU/PC

Connector Interfaces.

Connector Adapters (threaded).

Connector Adapters (threaded)

- 81000BA #002 Bare Fiber (125um)
- 81000GA D4
- 81000MA MU
- 81000PA E2000
- 81000VA ST

- 810003LA LC

Connector Adapters (with integral D-Shape)

81624DD D-Shaped adapter not required

- 81000BA #001 Bare Fiber 125um
- 81001FA FC
- 81001KA SC
- 81001LA LC
- 81001MA MU
- 81001PA E-2000
- 81001ZA BLANK Adapter

Integral D-Shaped Adapters

- 81003JD MT - RJ
- 81003PD MPX
- 81003TD MTP

High Power Optical Head (with integrating sphere)

OPTIONAL



Interface Module

- Interface Modules**
 81618A Single Head Interface Module
 81619A Dual Head Interface Module

High Power Optical Head for:
 Connectorized Fiber,
 Bare Fiber and
 Open beam $NA \leq 0.3$
 81628B InGaAs
 +40dBm to -60 dBm

- Accessories**
 81624CE 4m extension cable

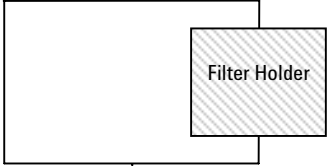

- Filter / Holder**
 81000AF Filter Holder

Connector Adapters
 (threaded).

- Connector Adapters (threaded)**
 81000BA #002 Bare Fiber (125um)
 81000FA FC
 81000KA SC

 81000GA D4
 81000MA MU
 81000PA E2000
 81000VA ST

 810003LA LC

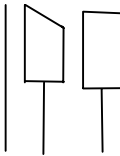

Return Loss modules

OPTIONAL

For Laser Safety see page 13



Return Loss Module
Angled contact interfaces

- 81610A Return Loss Module (without internal source)
- 81611A Return Loss Module (1310nm internal source)
- 81612A Return Loss Module (1550nm internal source)
- 81613A Return Loss Module (1310/1550nm internal source)

Connector Interface for angled contacts

Connector Interfaces for angled connectors

- 2 ea required for 81610A.
- 1 ea required for 81611/12/13A.
- (2 ea required if using external source input).

- 81000FI FC/APC keywidth 2.2mm
- 81000NI FC/APC keywidth 2.0mm
- 81000PI E-2000/APC
- 81000KI SC/APC
- 81000SI DIN 47256/APC
- 81002VI ST/APC
- 81000LI LC/APC
- 81000MI MU/APC

Reference Cable
 81610CC Reference Cable – for calibration of all 8161xA Return Loss Modules
 Connectors - DIN 47256/APC (connects to module) and FC/PC (supplied with calibrated return loss values to open air)
 An 81000SI connector interface is required to connect this cable to the module.
 This cable is used for calibration only, not for measurements.

Caution: Do not make physical contact to the FC/PC connector and do not attach another connector to it. This could change the calibrated (open) return loss values.

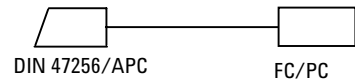

Optical Attenuator modules

OPTIONAL



Optical Attenuators with Straight Contact Connectors

81570A (single slot)
Optical Attenuator for high power
81576A (dual slot)
Optical Attenuator with Power Control for high power

Optical Attenuator
Straight Contact
Connectors

Optical Attenuator with
SMF pigtails
2m length

Optical Attenuator
Angled Contact
Connectors

Optical Attenuators with Angled Contact Connectors

81571A (single slot)
Optical Attenuator for high power
81577A (dual slot)
Optical Attenuator with Power Control for high power

 **Optical Attenuator with SMF pigtails**
81573A (single slot)
Optical Attenuator for high power

Connector Interfaces (input and output):

2 ea required

81000 FI FC/PC
81000 HI E-2000 PC
81000 KI SC/PC
81000 LI LC/PC
81000 MI MU/PC
81000 SI DIN 47256/PC
81000 VI ST/PC

Connector
Interface for
straight connectors

Connector
Interface for
angled connectors

Connector Interfaces (input and output):

2 ea required

81000FI FC/APC keywidth 2.2mm
81000NI FC/APC keywidth 2.0mm
81000 PI E-2000 APC
81000 KI SC/APC
81000 LI LC/APC
81000 MI MU/APC
81000 SI DIN 47256/APC
81000 VI ST/APC

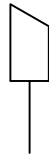
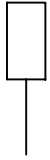

Laser Safety Information

81611A 1310 nm RL
81612A 1550 nm RL
81613A 1310/1550nm RL

81650A 1310 nm FP
81651A 1550 nm FP
81654A 1310/1550 nm

The laser sources listed directly above are classified as Class 1 according to IEC 60825-1 (2001).

All laser sources comply with 21 CFR 1040.10 except for deviations pursuant to Laser Notice No. 50, dated 2001-July-26.

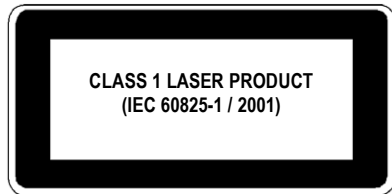

81655A 1310 nm FP
81656A 1550 nm FP
81657A 1310/1550 nm FP

81662A C- and L-Band DFB
81663A C-band DFB

81600B #200 1440 nm - 1640 nm All-band TLS
81600B #140 1370 nm - 1495 nm low SSE TLS
81600B #150 1450 nm - 1590 nm low SSE TLS
81600B #160 1495 nm - 1640 nm low SSE TLS
81600B #132 1260 nm - 1375 nm high power TLS
81600B #142 1370 nm - 1495 nm high power TLS

81940A 1520 nm - 1630 nm compact TLS
81949A 1520 nm - 1630 nm compact TLS
81980A 1465 nm - 1575nm compact TLS
81989A 1465 nm - 1575 nm compact TLS

All laser sources specified directly above are classified as Class 1M according to IEC 60825-1 (2001).

All laser sources comply with 21 CFR 1040.10 except for deviations pursuant to Laser Notice No. 50, dated 2001-July-26.

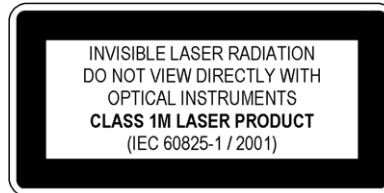

Agilent Technologies' Test and Measurement Support, Services, and Assistance

Agilent Technologies aims to maximize the value you receive, while minimizing your risk and problems. We strive to ensure that you get the test and measurement capabilities you paid for and obtain the support you need. Our extensive support resources and services can help you choose the right Agilent products for your applications and apply them successfully. Every instrument and system we sell has a global warranty. Support is available for at least five years beyond the production life of the product. Two concepts underlie Agilent's overall support policy: "Our Promise" and "Your Advantage."

Our Promise

Our Promise means your Agilent test and measurement equipment will meet its advertised performance and functionality. When you are choosing new equipment, we will help you with product information, including realistic performance specifications and practical recommendations from experienced test engineers. When you use Agilent equipment, we can verify that it works properly, help with product operation, and provide basic measurement assistance for the use of specified capabilities, at no extra cost upon request. Many self-help tools are available.

Your Advantage

Your Advantage means that Agilent offers a wide range of additional expert test and measurement services, which you can purchase according to your unique technical and business needs. Solve problems efficiently and gain a competitive edge by contracting with us for calibration, extra-cost upgrades, out-of-warranty repairs, and on-site education and training, as well as design, system integration, project management, and other professional engineering services. Experienced Agilent engineers and technicians worldwide can help you maximize your productivity, optimize the return on investment of your Agilent instruments and systems, and obtain dependable measurement accuracy for the life of those products.

By internet, phone, or fax, get assistance with all your test & measurement needs

Online assistance:

www.agilent.com/comms/lightwave

For related literature, please visit:

www.agilent.com/comms/lwmainframes

Phone or Fax

United States:

(tel) 1 800 452 4844

Canada:

(tel) 1 877 894 4414

(fax) (905) 282-4120

Europe:

(tel) (31 20) 547 2323

(fax) (31 20) 547 2390

Japan:

(tel) (81) 426 56 7832

(fax) (81) 426 56 7840

Latin America:

(tel) (305) 269 7500

(fax) (305) 269 7599

Australia:

(tel) 1 800 629 485

(fax) (61 3) 9210 5947

New Zealand:

(tel) 0 800 738 378

(fax) 64 4 495 8950

Asia Pacific:

(tel) (852) 3197 7777

(fax) (852) 2506 9284

Product specifications and descriptions in this document subject to change without notice.

Copyright © 2003 Agilent Technologies

July 01, 2003

5988-1571EN



Agilent Technologies